

# Silva Cell<sup>®</sup> Fact Sheet

---

A detailed guide and sizing manual for the application of Silva Cells to meet the requirements of bioretention under paving.

Copyright © 2018 by DeepRoot Green Infrastructure, LLC

All rights reserved. No part of this publication may be reproduced, distributed, or transmitted in any form or by any means, including photocopying, recording, or other electronic or mechanical methods, without the prior written permission of the publisher, except in the case of brief quotations embodied in critical reviews and certain other noncommercial uses permitted by copyright law.

# Silva Cell Fact Sheet

---

A detailed guide and sizing manual for the application of Silva Cells to meet the requirements of bioretention under paving.

Prepared for  
**DeepRoot Green Infrastructure, LLC**

101 Montgomery Street, Suite 2850  
San Francisco, CA 94104  
415.781.9700  
[deeproot.com](http://deeproot.com)

Prepared by  
**Geosyntec Consultants, Inc.**

1111 Broadway, 6th Floor  
Oakland, California 94607  
*Original printing 2017. Reprinted 2018.*

# Table of Contents

## 1

---

### **Intro to Silva Cell Systems**

Silva Cell System Overview, page 7

Frequently Asked Questions for Stormwater Management Applications, page 10

## 4

---

### **Design Guidelines**

Facility Geometry, page 23

Inlet and Flow Distribution Design, page 26

Outlet Design, page 32

Soil Media Guidelines, page 34

Tree Selection Guidelines, page 35

# 2

---

## Silva Cell Design Configuration

Overview of Silva Cell Design Configurations for Stormwater Management, page 13

# 3

---

## Site Suitability Considerations

Siting and Tributary Area Considerations, page 17

Considerations for Underlying Soil and Groundwater Conditions, page 18

Physical Siting Considerations, page 20

Options for Adaptation of System Design to Infiltration Feasibility Conditions, page 21

# 5

---

## Sizing Guidelines

Terms and Concepts Associated with Silva Cell Sizing, page 38

Calculating Retention Volume, page 40

Calculating Biofiltration Volume, page 40

Guidelines for Ensuring Full Utilization of Soil Pores, page 41

General Guidance for Modeling Silva Cell Systems in Computer Modeling Programs, page 42

# 6

---

## Operations and Performance

Construction Considerations, page 45

Operations and Maintenance Activities, page 46

Performance Data, page 48

---

References & Patents, page 50





# Intro to Silva Cell Systems

## Silva Cell System Overview

The Silva Cell system is a modular green infrastructure facility that can be designed to provide stormwater management benefits equivalent to bioretention. The system is typically installed under pavement applications and can be configured in several different ways.

The core element of the system is the Silva Cell module. For stormwater management applications, depending on how flow is distributed and collected, Silva Cell systems can provide filtration and/or infiltration. The Silva Cell modules are typically filled with filtration soil media (similar to a bioretention-type system), but can also be left as void space to increase the volume of stormwater storage capacity for infiltration or detention systems. A variety of different stormwater inlet types and underdrain collection methods are supported.

## Typical applications of Silva Cells include:

---



1

### Streetscapes

adjacent to or under sidewalks  
between buildings and streets.

2

### Parking Areas

under parking stalls adjacent  
to medians or islands.

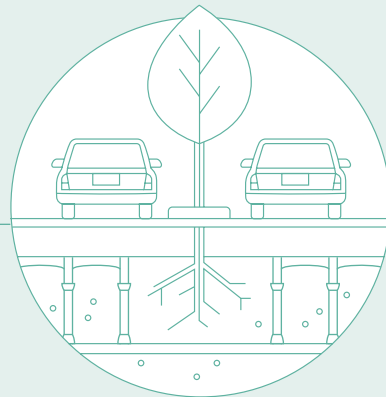



# 3

## Public Spaces

under plazas, promenades, courtyards, or other public spaces at office buildings, museums, schools, and transit centers.

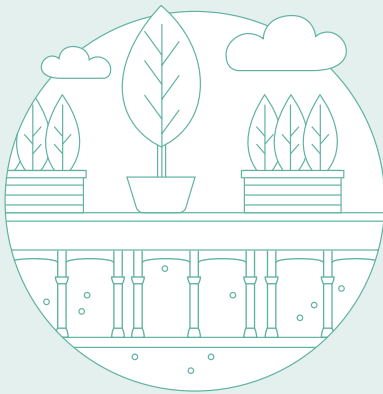

# 4

## Green Roofs

on structures in balconies or roof spaces to support trees and collect discharge.

# 5

## Green Walls

adjacent to green walls to extend storage and treatment benefits.

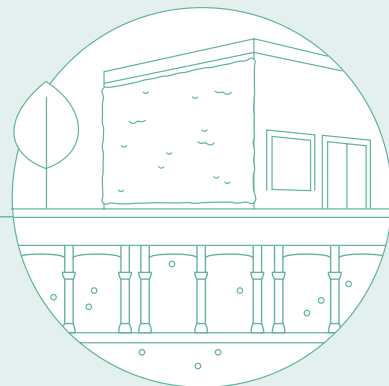



Above Underdrain being installed at base of system

## Frequently Asked Questions for Stormwater Management Applications

### Is the Silva Cell system a bioretention cell?

Yes. Silva Cells are a modular pavement support system that can be designed to allow the space under paving to function equivalent to bioretention. Silva Cell bioretention facilities have been demonstrated to achieve similar water quality outcomes to typical bioretention. The system can also be configured similarly to other stormwater best management practices (BMPs), including systems similar

to underground vaults or chambers, to provide storage for infiltration or flow detention.

### Is the Silva Cell system a vault or “tree pod” system?

No, Silva Cells are a modular pavement support system which can be used to install bioretention under the pavement. An engineer must size the system and select or design the components of the underground bioretention system (e.g. media) that will be used with the Silva Cell system to achieve equivalent performance to bioretention. This fact sheet describes how an engineer can design a bioretention equivalent system below pavement using Silva Cells.

## What are the key elements of a Silva Cell design for stormwater management?

In order to serve as green infrastructure for stormwater management, key elements include: a stormwater inlet system, pretreatment system (where needed), flow distribution system, Silva Cell modules, appropriate tree(s), and a flow collection system (e.g., underdrain, where needed) with a connection to an appropriate discharge point.

## Have Silva Cells been accepted as a treatment BMP by Regulators or Municipal Reviewers?

Silva Cells have been implemented in municipalities across the United States, Canada, and the United Kingdom. Silva Cells have been approved as a treatment technology by several agencies, often as an equivalent to other stormwater management approaches.

## What is the suggested Silva Cell soil mix for stormwater management applications?

In general, the soil mix used for a bioretention-like application should be consistent with local bioretention or biotreatment soil mix requirements. This Fact Sheet provides suggested soil mixes and properties for locations where local bioretention soil mix requirements have not been adopted.

## How do Silva Cells support a tree?

Silva Cells support a tree by providing sufficient soil volume for the tree roots to expand within the modular system (below the pavement) and by reducing soil compaction.

## Do Silva Cells require maintenance?

Silva Cells require minimal maintenance. The inlet/outlet structures, distribution pipes, and underdrain pipes require periodic cleanout. The trees in the system will require annual landscape maintenance and irrigation.

## Is pretreatment required?

Pretreatment should be installed per the local requirements for bioretention facilities. A range of approaches may be appropriate. Additional information is provided in the “Inlet Design” section.

## How does stormwater enter the Silva Cell?

There are multiple possible configurations for the inlet design, including a catch basin inlet connected to a flow distribution pipe, percolation through pervious pavement above the Silva Cells, inlet pipes from roof leaders, or inflow from pretreatment devices. Additional details and information are provided in the “Inlet Design” section.

## Does the area where my tree is planted count as treatment area?

Though the area taken up by the tree does provide biotreatment and evapotranspiration benefits, because the soil directly adjacent to the tree typically does not consist of bioretention media formulated similar to locally applicable standards (when installed), the area of the tree root ball at installation is often not included in treatment area calculations. Inclusion of this area may be allowed by certain jurisdictions.

# Silva Cells have been implemented across the United States, Canada, and the United Kingdom.



# 2

## Silva Cell Design Configuration

### Overview of Silva Cell Design Configurations for Stormwater Management

There are two main configurations of Silva Cell systems for stormwater management. These include:

#### 1

##### Bioretention Equivalent Design —

This configuration includes an inlet system that distributes flows throughout the system and a typical bioretention cross-section, including a gravel drainage layer at the base of the facility, Silva Cell modules filled with bioretention or biofiltration media, and an open ponding layer provided within the modules. For standard non-infiltrating

bioretention, the underdrain is set below the base elevation of the system. Stormwater is distributed and percolates through the bioretention media, receiving treatment, and treated stormwater flows out of the underdrain. This configuration provides only limited incidental infiltration below the facility, or no infiltration if lined. The main treatment mechanism is filtration.

## 2

### Bioinfiltration Equivalent Design —

Bioinfiltration refers to a bioretention system that allows for partial infiltration of stormwater. To achieve this, the underdrain is upturned at the outlet of the system (or

raised, as space allows) to provide a sump within the system that can only leave the system through infiltration. This configuration is used when it is desirable to maximize the retention of the system in soils less conducive to infiltration, while still providing treatment.

Key features of the bioretention equivalent design are identified in Figure 1, pg 14. Note that the depths of media and ponding layers shown in Figure 1 are intended to illustrate that the Silva Cell system can accommodate typical bioretention media depths; however, these media depths may change based on local requirements and/or engineering design decisions and calculations.

A schematic of a Silva Cell system configuration integrated into a streetscape is provided in Figure 2, pg 15.

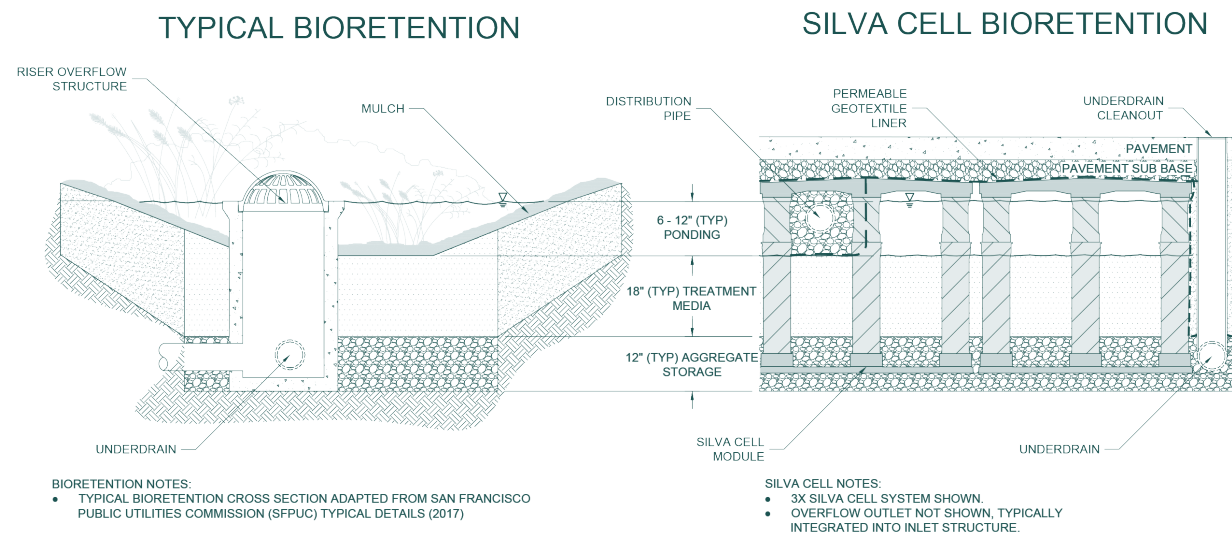

### SILVA CELL SYSTEM SIZES

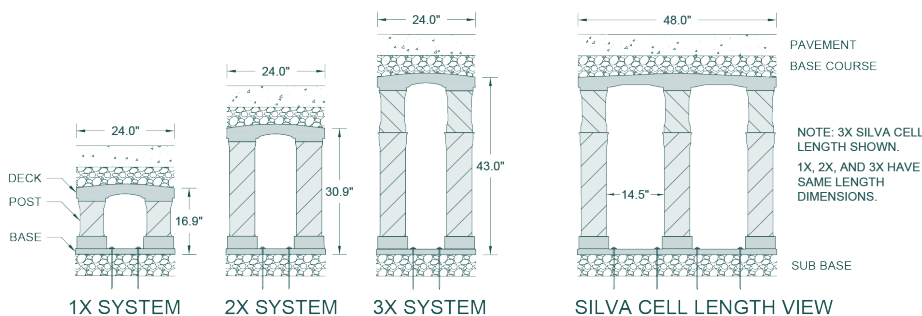
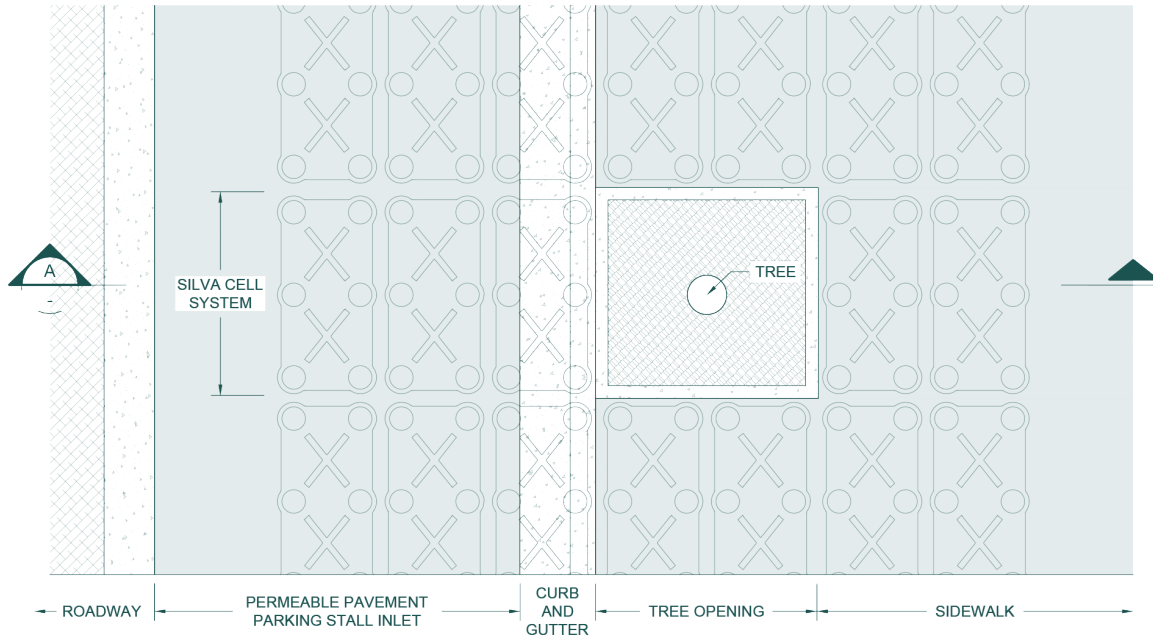

FIGURE 1: SILVA CELL COMPONENTS

FIGURE 1

### Bioretention Schematic

## PLAN VIEW



## CROSS SECTION A

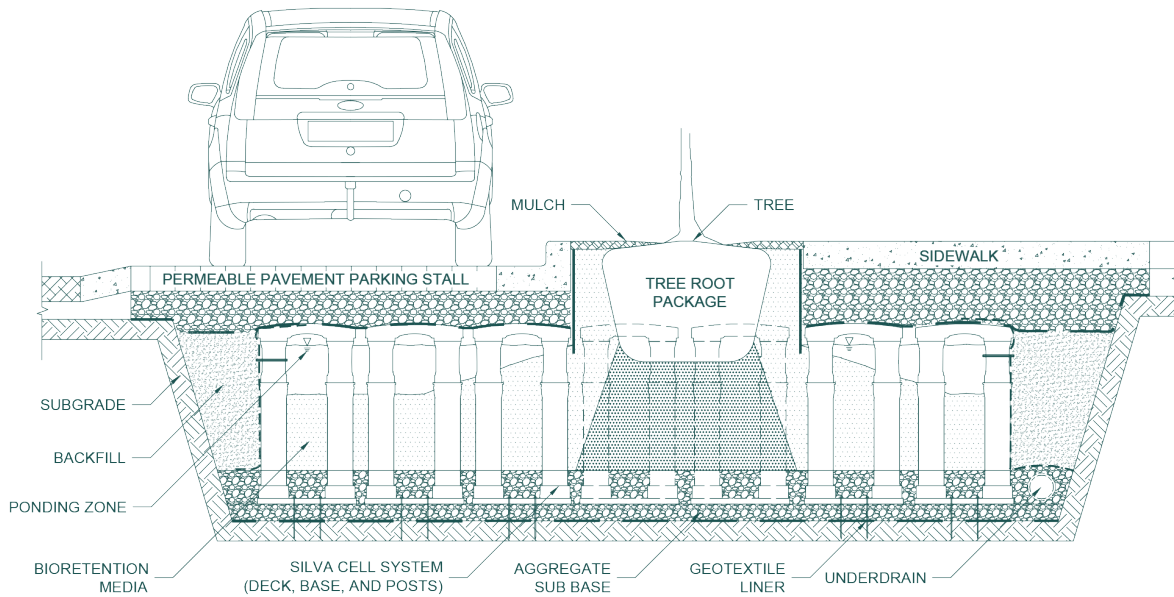

NOTE: MEETS AASHTO HS-20 (USA) CSA-S6, 87.5 AND OBC 54KN (CANADA), AND BS EN 1991-1-1:2002 BS EN 1991-1-2:2003 (UK) LOADING STANDARDS WHEN USED WITH STANDARD PAVING PROFILES. INCREASED LOADING CAPACITY CAN BE ACHIEVED BY ADJUSTING THE STANDARD PROFILES.  
[HTTP://WWW.DEEPROOT.COM/PRODUCTS/SILVA-CELL/LANDING-PAGE/SILVA-CELL-2/ENGINEERING](http://www.deeproot.com/products/silva-cell/landing-page/silva-cell-2/engineering)



**Geosyntec**<sup>®</sup>  
 consultants  
 engineers | scientists | innovators

FIGURE 2: SILVA CELL TYPICAL APPLICATION

FIGURE 2

Simple Schematic Drawing of System Overview





# 3

## Site Suitability Considerations

### For Stormwater Management Applications

#### Siting and Tributary Area Considerations

There are several factors that should be considered prior to siting a Silva Cell system. These factors may require additional components, alternative configurations, or specific pretreatment systems.

#### 1

**Under-pavement applications** — Silva Cells can be sited under many different pavement applications, including parking lots, service driveways, emergency vehicle access ways, medians, dedicated parking lanes, and other pavement configurations. In general, it is not recommended to site Silva Cells under active travel lanes.

## 2

### Other loading (i.e., weight)

**considerations** — Silva Cells have been tested and shown to support the loading requirements in excess of the AASHTO H/HS-20 standard. Load bearing capacity can be increased or decreased with adjustments to the pavement profile. Consult DeepRoot or an engineer if it is desired to site the system under land uses expected to have greater loading. <http://bit.ly/Test-conclusions>

## 3

**Silva Cell facility size** — Any number of Silva Cells can be configured to form a system, provided that the influent stormwater is distributed evenly throughout the system. Generally the system has a minimum of 10 but can extend to hundreds or thousands.

## 4

**Proximity to storm drain** — How the facility will connect to the storm drain is an important design consideration. Most configurations utilize a storm drain connection unless the underlying soils can support full infiltration of the stored water.

## Considerations for Underlying Soil and Groundwater Conditions

The subbase is an important component of Silva Cell systems. In most cases, Silva Cells should be installed on top of 95% compacted soil subgrade. Considerations for the subgrade include:

### 1

**Native soil composition** — Composition of the native soil is an important factor for both the structural requirements of the system as well as potential for infiltration, if desired. The native soil should provide sufficient strength when compacted to achieve Silva Cell loading requirements of 95% compaction. A geotechnical engineer should be consulted to identify whether infiltration is feasible/allowable given the in-situ soil types. If infiltration is feasible, a geotechnical engineer may be consulted to waive the requirement to compact the subgrade to 95% to allow for infiltration, provided that the loading requirements are still met. Infiltration rates should be assessed after compaction has been completed.

### 2

**Depth to groundwater, bedrock, or low permeability soil layer** — In general, the system should be located above the seasonal high groundwater table except in special conditions where such siting is unavoidable. For designs that will utilize infiltration, the design should adhere to local requirements for separation of the system base from groundwater, bedrock, or low permeability soil layers.

*Right* Distribution pipe shown within ponding depth



### 3

#### Groundwater contamination, contaminated soils, or groundwater plumes

— If soil or groundwater contamination or plumes are known to be present in the proposed location of the facility, the best practice is to remediate the contamination via treatment or removal prior to installing the system. Following remediation, or if full remediation is not achievable, an impermeable membrane liner is recommended to be installed below the system and along vertical walls or side slopes to avoid additional mobilization of pollutants from intentional or incidental infiltration.

## Physical Siting Considerations

### 1

**System setbacks** — Installation of Silva Cells requires 95% compaction of at least 12 inches around the system perimeter. In general, this setback should be provided when siting the system adjacent to foundations or in-place curb systems. Refer to local requirements for infiltrating facilities when planning for setbacks from structures, such as buildings and curbs, water-based infrastructure, like drinking water supply wells, or potential sources of contamination, such as septic fields.

### 2

**Underlying slope** — Silva Cells can be installed on slopes up to 5% when full load-bearing capacity is needed. Slopes of up to 10% are allowable for locations requiring less load-bearing capacity. Consult DeepRoot for additional information if siting on slopes is desired.

### 3

**Slope stability** — If slope stability is a concern in or adjacent to the location of the Silva Cell, it is recommended that a geotechnical engineer be consulted to ensure that introduction of water to the subgrade would not lead to slope failure. If it is determined that a facility can be sited, an impermeable liner is recommended to minimize introduction of water to the subgrade.

### 4

**Grade differentials from tributary area to Silva Cell areas** — Slopes in the tributary area of 15% or greater can result in erosion, increased sediment transport, and preferential flow paths. Local requirements should be considered when siting in an area with large grade differentials. When local guidance is not available, it is recommended that energy dissipation be implemented on steep slopes to avoid erosive flow and pretreatment be provided to capture entrained sediment.

## Options for Adaptation of System Design to Infiltration Feasibility Conditions

Depending on applicable requirements and local infiltration feasibility criteria, stormwater treatment facilities may need to be designed to maximize infiltration. Silva Cells can be configured to maximize infiltration in a range of soil conditions:

- Conditions where full infiltration of a stormwater design volume is feasible and desirable: No underdrain is provided, or a backup underdrain is provided and is normally capped (recommended). Compaction of the subgrade is minimized while providing adequate loading to meet intended use of paving.
- Conditions where partial infiltration is desirable but infiltration rates are marginal: An underdrain is provided, but an upturned elbow is attached to the underdrain where it discharges from the system, effectively holding back a portion of the storage volume to infiltrate over time. The height of this upturned elbow can be adapted to be compatible with site-specific infiltration rates. In these cases, it is recommended a geotechnical engineer be consulted to confirm that saturated soils will provide sufficient load-bearing capacity.

- Conditions where some incidental infiltration is acceptable: An underdrain is provided and set near the bottom of the facility.
- Conditions where no infiltration is allowable: An underdrain is provided and set near the bottom of the facility. The system is lined with an impermeable liner.

---

Local guidance and/or criteria should be followed, as applicable, in determining the feasibility of infiltration at a given location.

**Silva Cells can be configured to maximize infiltration in a range of soil conditions.**



# 4

---

## Design Guidelines

### For Stormwater Management Applications

#### Facility Geometry

The Silva Cell system is sized to capture the stormwater quality design volume required by local regulations. Components of the Silva Cell system are shown in Figures 1 and 2 and described below:

#### 1

---

**Subgrade** — The system is installed on 95% compacted native soil to support the system load unless a geotechnical engineer has indicated another compaction level is acceptable (e.g., to support infiltration below the facility).

## 2

**Subbase** — A geotextile liner is installed above the subgrade. Where infiltration is not allowed, this will include an impermeable high-density polyethylene (HDPE) geomembrane. For systems in which infiltration is allowable, a geotextile fabric or geogrid<sup>1</sup> may be installed. Above the geotextile or geogrid, a washed aggregate basecourse is installed to at least a 4-inch depth. The aggregate basecourse can be installed per the gradation recommended in DeepRoot’s technical specifications (<http://bit.ly/silva-cell>), or an open graded drain rock may be provided to allow for drainage through the subbase.

## 3

**Silva Cells** — The Silva Cells are placed on top of the subbase. These cells consist of a base, posts, and a top deck. The posts are provided in three different depths, shown in **Table 1** and summarized below. The Silva Cells are filled with media, or can be filled part-way with media and have some open ponding above the media.

TABLE 1

**Silva Cell Post Depth**

Silva Cell Module Type	Silva Cell Module Depth (inches/mm)	Minimum Facility Depth (inches/mm)
1x	16.7"/424	28.7"/729
2x	30.9"/784	42.9"/1089
3x	43"/1092	55"/1397

## 4

**Gravel Drainage Layer** — The gravel drainage layer is installed within the Silva Cell modules, at the bottom of the modules. This drainage layer is equivalent to the typical drainage layer that would be provided in a standard bioretention facility. Depending on the underdrain configuration (see “Outlet Design”), the full gravel depth (per local requirements) should be provided above the base of the module, or the subbase can be included as part of the full gravel depth (this option is shown in Figure 1, pg 14).

## 5

### **Bioretention/Biotreatment Media Layer**

— The bioretention or biotreatment media is provided above the gravel drainage layer to the depth required by local criteria (typically 18 inches, shown in Figure 1, pg 14). Choking stone should be provided, if required by regional guidelines, between the gravel drainage layer and the media layer to avoid migration of fines. Refer to local requirements for specifications if available.

<sup>1</sup> A geogrid is a geosynthetic material made of polymers that are fused in a net-like configuration. Geogrids are manufactured with varying material flexibility and a range of sizes of openings. Geogrids serve to reinforce and contain soils and aggregate materials.



## 6

### Ponding Layer/Flow Distribution Layer —

Within the modules, above the media layer, a ponding layer can be provided to the depth required by local criteria to provide flow distribution throughout the system (this is shown as 12 inches in Figure 1, pg 14). Distribution pipes, connected to the inlet, should discharge directly into this ponding layer and/or be placed within this layer. If distribution pipes are installed within this layer, they can be surrounded by a washed aggregate blanket per local requirements and wrapped with a geotextile, to allow for distributed flow and ponding throughout the system.

## 7

**Pavement Subbase** — Above the top deck of the Silva Cell modules, a pavement subbase aggregate layer should be installed, consistent with standard pavement or permeable pavement design. See standard Silva Cell details and Figure 1, pg 14.

## 8

**Asphalt, Concrete, or Pavers** — Standard or pervious concrete, asphalt, or pavers are installed above the top layer of the system. Pavers and pervious layers may require a specific bedding layer(s) and should be installed per the DeepRoot standard paving specifications. See Figure 3, pg 29 for these standards.

## 9

**Perimeter** — Installation may require the facility location to be surrounded by side slopes of specific dimensions, governed by the local requirements. The Silva Cells are surrounded by a geogrid secured to the Cells with a cable tie or zip ties. Side slopes, if present, are backfilled. The system underdrain is typically installed in the backfill. See the “Outlet Design” section for additional details.

## 10

**Tree** — A tree is installed within the bioretention or biotreatment media or compacted planting material located within the Silva Cell modules or immediately adjacent to the system. A root barrier is installed around the top edge of the tree opening to direct roots into the bioretention media in the Silva Cell system and to prevent root intrusion into pavement. The dimensions for a tree opening and other details are provided in the “Tree Selection Guidelines” section.

## Inlet and Flow Distribution Design

Effectively and reliably conveying stormwater into the Silva Cell system and distributing it within the ponding layer to allow for even percolation through the media is among the most important design considerations. There are multiple options for configuring inlets and flow distribution systems for the Silva Cell system.

### General Guidance

The following general guidance applies to any inlet configuration:

- 1 An appropriate degree of pretreatment should be provided. Additional discussion is provided below.
- 2 Where there is potential for inflow to scour the surface of the media, energy dissipation should be provided. This is rare and only applies where water flows directly into the surface of the system into exposed media.
- 3 The inlet should have adequate hydraulic capacity to convey the target design flowrate into the system.
- 4 The inlet should be reasonably resilient to trash and sediment accumulation.<sup>2</sup>
- 5 The flow distribution system should effectively distribute water throughout the system. Flow distribution pipes are installed within a distribution/ponding layer which allows for water to be distributed and stored prior to percolating through the media.
- 6 Only the volume of the system that is located below the overflow bypass elevation can be counted as storage volume for water quality design purposes. This may be an important consideration in inlet and bypass/overflow design.

### Recommended Inlet Configurations

Guidelines for inlet components are included in the following sections. The inlets described are shown in figures included in this Fact Sheet as referenced. Additional details on inlet design are provided in the Design Documents and Stormwater Schematics brochure provided on the DeepRoot website (<http://bit.ly/silva-cell>).

#### 1

##### Pipe from catch basin or diversion pipe —

A common facility inlet consists of a pipe draining into the facility from an adjacent catch basin. The inlet pipe is typically connected to a distribution pipe installed within the Silva Cell, which is located within the upper rock layer to serve as a distribution system over the top of the media. See Figure 3, pg 29.

#### 2

##### Permeable paving —

Permeable concrete, asphalt, or pavers installed above the Silva Cell facility allow for runoff and direct rainfall on the permeable paving to percolate down into the system below. See Figure 2, pg 15.

<sup>2</sup> Silva Cells are not intended for use as trash management devices. If trash management is needed, this should be provided in an upstream pretreatment device.

### 3

**Roof leader** — A roof leader inlet drains rainfall collected on an adjacent roof through a downspout and into the Silva Cell facility, where it is connected to a distribution pipe, which conveys flow into the upper rock layer to serve as a distribution system. See Figure 4, pg 30.

### 4

**Trench drain** — A trench drain inlet consists of a long, narrow grate drain, sometimes installed with aggregate. The drain acts as an inlet and is typically sloped to allow for water to flow to a collection point, from which it is distributed throughout the system via typical distribution configuration. Typically, a trench drain is only installed when sheet flow is expected from the drainage area. See Figure 4, pg 30.

### 5

**Pretreatment device** — Inflow can enter the Silva Cell system directly from a pretreatment device. This may include a proprietary system or small engineered pretreatment area. The outlet of the pretreatment device

would connect to a distribution pipe, similar to other configurations. The pretreatment device outlet would be hydraulically connected to the distribution pipe. The depth of the pretreatment device outlet and elevation of the distribution pipe must be considered when selecting a pretreatment system, so that it is compatible with the system hydraulics. A generic pretreatment configuration is displayed in Figure 4, pg 30.

### 6

**Inlet from Road Verge<sup>3</sup>** — Similar to a pretreatment inlet, if there is a swale or other vegetated area installed within the Road Verge, this system could be connected to a Silva Cell installed under the adjacent sidewalk. The outlet pipe from the swale or vegetated area could serve as the inlet pipe and flow distribution system to the Silva Cell system. If the swale or vegetated area is designed as a pretreatment BMP, the pretreatment BMP would typically be sized to manage a flow or volume smaller than the design storm (refer to local requirements for sizing of pretreatment BMPs). See Figure 4, pg 30.

---

<sup>3</sup> The road verge is the space in the right-of-way between the road and the sidewalk.

## Distribution Pipe and Aggregate Layer

A distribution pipe connected to an inlet should consist of 4-inch slotted polyvinyl chloride (PVC) pipe spaced at an average of 10 to 15 feet on-center. The distribution pipe should be sloped at a minimum of 0.5% to allow positive flow through the facility. In a bioretention configuration, the distribution pipes can be placed within the ponding layer and wrapped in an aggregate blanket and geotextile or per local BMP guidelines (see Figure 3, pg 29). The aggregate blanket should be designed per local guidance, or if none is available, extend on all sides of the distribution pipe to create a pipe and aggregate section at least 12 inches thick and 12 inches wide, extending the length of the pipe.

Distribution pipe(s) and a distribution layer may not be needed when permeable pavement is used as the inlet to the system or in sufficiently small systems.

---

## Pretreatment Recommendations

Pretreatment should be installed per local requirements. In general, pretreatment should be installed corresponding with the anticipated pollutants from the tributary land areas. For most low-traffic roadway areas, the detention provided in a catch basin invert, along with a trash guard, should be sufficient to allow for settling of sediments and trash capture that could clog the system (unless local requirements dictate other types of trash management).

If high levels of sediment are expected, the area expected to produce sediment should be stabilized (if the source is from areas of high erosion) or bypassed around the system (if part of natural sediment transport processes). If stabilization is not feasible, then pretreatment should be installed to prevent migration of sediment into the Silva Cell system. Similarly, if specific pollutants are expected in the area,

a specific pretreatment system targeting that pollutant should be installed. Special cases may also require specialized pretreatment. For instance, a roof leader inlet may require a downspout screening device to avoid accumulation of leaf litter or roof grit in the inlet piping and flow distribution system.

If the Silva Cell is connected to another BMP as part of a treatment train system, such as permeable pavement, bioretention, or a bioswale, pretreatment may be adequately provided by that BMP.

Examples of a pretreatment inlet to the Silva Cell system and an inlet from the road verge are provided in Figure 4, pg 30.

---

## Energy Dissipation

If water flows directly into the system via a tree well or a vegetated surface, energy dissipation should be provided. This could involve installation of aggregate or concrete pads to reduce inflow velocities and prevent erosion.

---

### PLAN VIEW

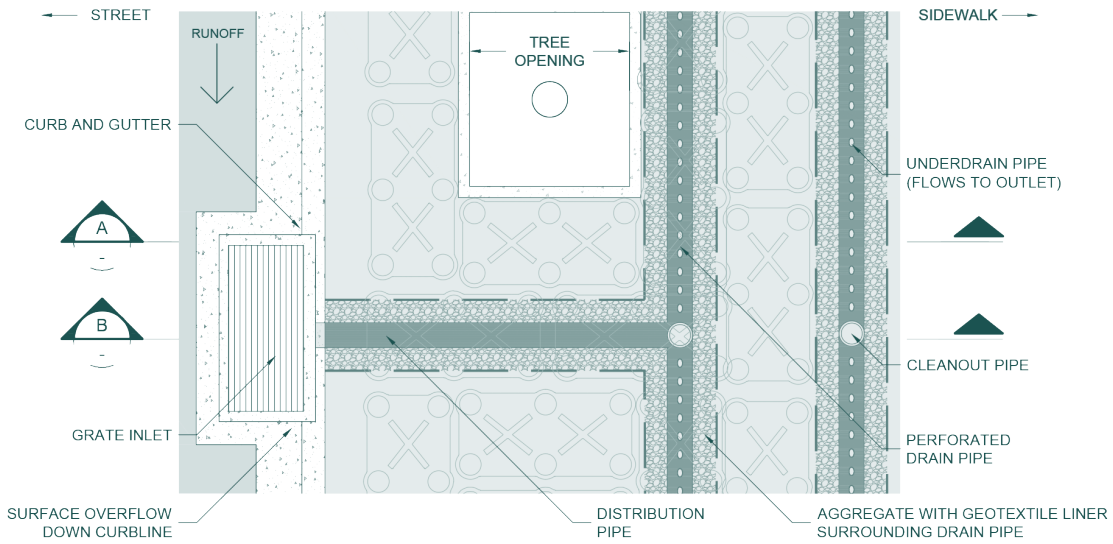

### CROSS SECTION A

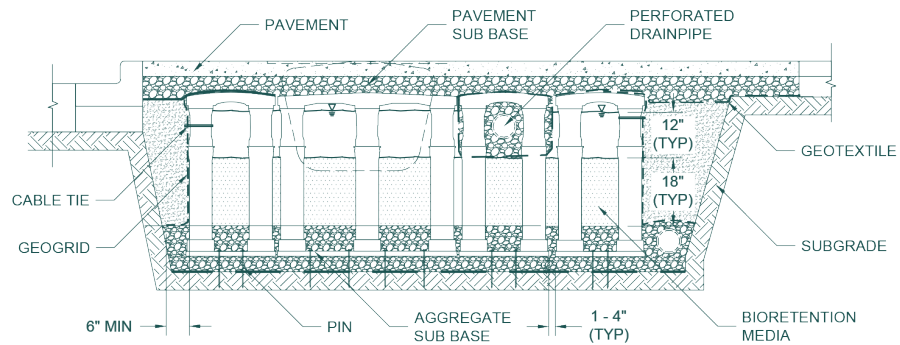

### CROSS SECTION B

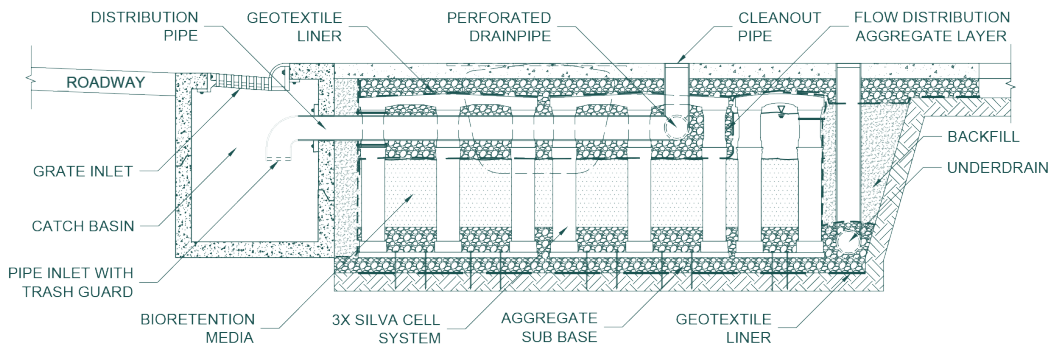

NOTE: SEE FIGURE 4 FOR ALTERNATE INLET CONFIGURATIONS.

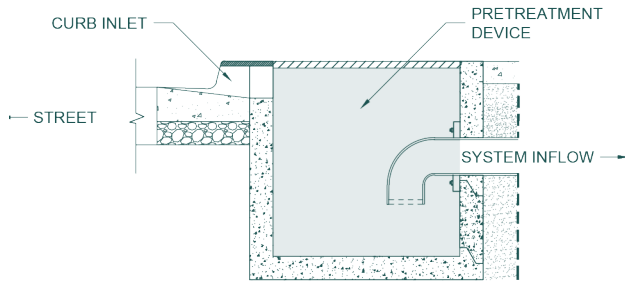

FIGURE 3: SILVA CELL HYDRAULIC COMPONENTS

FIGURE 3

### Silva Cell Hydraulic Components

## PRETREATMENT



NOTE: PRETREATMENT DEVICE INSTALLED PER MANUFACTURER RECOMMENDATIONS. OPTIONS INCLUDE HYDRODYNAMIC SEPARATORS, FILTRATION DEVICES, AND FLOW REGULATORS.

## ROAD VERGE

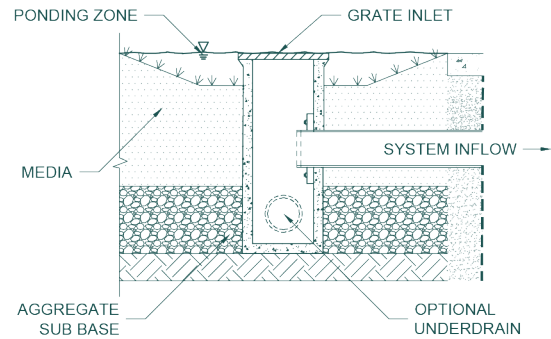

NOTE: SWALE AND BIORETENTION ROAD VERGE CONFIGURATIONS POSSIBLE.

## TRENCH DRAIN

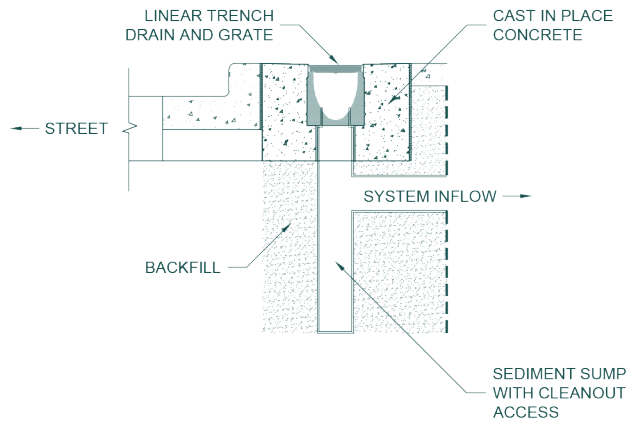

NOTE: SEE FIGURE 2 FOR PERMEABLE PAVEMENT INLET AND FIGURE 3 FOR CATCH BASIN INLET. SEE FIGURE 3 FOR INLET CONNECTION TO SILVA CELL.

## ROOF LEADER

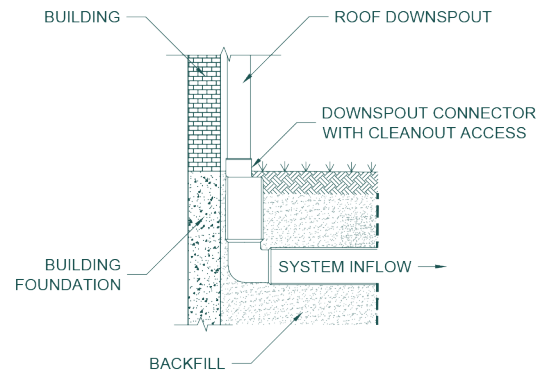

FIGURE 4: SILVA CELL INLET DETAILS

FIGURE 4

### Silva Cell Inlet Configuration Options

## High Flow Bypass or Overflow Design

A high flow bypass or overflow should typically be designed as part of the inlet system to avoid localized flooding and prevent pollutant loads from larger storms from entering the system. The configuration of the overflow for varying inlet types is described in the sections below:

### 1

#### Pipe from catch basin or diversion pipe —

The overflow pipe is located within the catch basin. The invert of the overflow device is set at the top of the Silva Cell system, such that when the Silva Cell facility is sufficiently full, additional water is not allowed to flow into the system and instead bypasses directly to the storm drain. Alternatively, water can be allowed to fill to the grate of the inlet and bypass down the curb line to a high flow bypass inlet when the Silva Cell system fills.

### 2

**Permeable paving** — The typical approach is to overflow via surface flow on the permeable pavement. When the Silva Cell fills, it will pond onto surface of the lowest areas of the permeable pavement. A secondary high flow overflow inlet should be provided at the surface of the permeable pavement to receive water so that it does not flood the adjacent roadway or walkway.

### 3

**Roof leader** — The roof leader inlet device can be designed to only convey up to a maximum flow rate into the facility. Additional flow bypasses the facility and outflows to the storm sewer through a separate pipe.

### 4

**Trench drain** — Sheet flow ponds above the grate, which is typically recessed towards a low point to allow for overflow ponding. An overflow outlet connected directly to the storm drain is typically installed adjacent to the recessed trench drain to capture additional overflow.

### 5

#### Pretreatment device, or inlet from Road

**Verge** — When inflow is entering the Silva Cell facility from a BMP, pretreatment device, or vegetated area, the overflow is typically provided as part of the design of the initial facility. Flows exiting the BMP, pretreatment device, or vegetated area are therefore sufficiently controlled to prevent overflow within the Silva Cell facility.

## Outlet Design

Currently, there are two typical methods for Silva Cell system outlets – underdrains (the majority of facilities) and infiltration. These outlet types are described in the following sections. The flow rate through the Silva Cell system is controlled based on the media installed (for media-limiting flow rates) or by a controlled outlet configuration. Media recommendations are provided in later sections of this Fact Sheet.

---

### Underdrains

In most cases, an underdrain is recommended to be provided to convey flows out of the system:

- 1 To promote uniform vertical flow through the media from the distribution system to the underdrain collection system, it is recommended that drain rock be provided within and below the Silva Cell modules to encourage positive flow towards the underdrain, or, in the case of large facilities, perforated underdrain laterals be installed within the gravel layer to cover approximately two-thirds of the plan view area of the system. Underdrain laterals may also be installed in trenches below the modules.
- 2 The underdrain is located at the base of the facility within the subbase aggregate layer or adjacent to the Silva Cell system, surrounded by aggregate blanket, and located hydraulically below the base of the facility to provide complete drainage (recommended for lined facilities). If a sump is desired for promotion of infiltration or creation of an anaerobic zone for nutrient removal, the underdrain should still be installed at the bottom of the system, but an upturned elbow can be affixed to the underdrain at the outlet catch

basin to create an internal water storage zone that flows directly into the surface of the system into exposed media.

- 3 The pipe material should be selected per locally accepted designs. If local details are unavailable, typically a slotted PVC drainage pipe is recommended for use for the underdrain, with a minimum 6-inch diameter. Underdrains should be sloped at a minimum of 0.5% towards the main collector pipe or outlet to provide positive drainage.
- 4 Cleanouts are recommended to be connected to the underdrain system and installed at a frequency of one riser per three trees. Cleanouts should consist of rigid, PVC schedule 40 pipe of at least the diameter of the underdrain. A cap consisting of solid threaded cast iron that fits standard schedule 40 pipe-fittings should be included. When embedded in pavement, the cap should be flush with the pavement surface.

---

### Infiltration

Infiltration should only be used as the sole facility outlet where there is high confidence that the underlying soil can provide sufficient infiltration (when 95% compacted) and where local requirements allow it. The design infiltration rate must be greater than the locally-required minimum infiltration rate for infiltration facilities and should be determined through locally accepted testing methods of the in-situ soils at the facility location.

When infiltration is the sole facility outlet, it is recommended that inspection risers be installed to allow the system to be inspected for drainage operation. Inspection risers should be installed adjacent to tree openings at a frequency of one riser for every two trees and consist of rigid, PVC schedule 40 pipe of at least 6 inches in diameter. A cap consisting of solid threaded cast iron that fits standard schedule 40 pipe-fittings should be included.

An underdrain installed per the guidance above but normally capped, to promote infiltration, is strongly





recommended. This is a minor additional expense and provides a means to drain the system if infiltration rates are lower than expected. The underdrain can be uncapped to convert the system to a filtration system.

---

## Soil Media Guidelines

There are generally two types of soil media used in Silva Cell systems: planting soil and bioretention soil media. These media serve different purposes and have different design requirements.

---

### Planting Soil

Planting soil is intended to support tree growth and to support transpiration losses. It does not need to be permeable enough to support filtration processes as it typically takes up a relatively small portion of the system volume. The planting soil is typically placed surrounding the tree root ball; for bioretention applications, bioretention media is used throughout the remainder of the system. Unless otherwise determined by project design professionals, the specifications for planting soil found in DeepRoot's Soils Specifications (<http://bit.ly/silva-cell>) can be utilized but are not required. DeepRoot does not supply soil. These specs are provided as a courtesy.

---

### Bioretention Soil Media

Bioretention soil media is intended primarily to store and filter stormwater and to provide some support for tree root growth. For designs to be equivalent to bioretention, the locally-acceptable bioretention soil media specification should be followed. Most jurisdictions have a bioretention soil specification, or refer to the specifications used by other jurisdictions.

If there is not a locally-applicable specification, the following specifications could be consulted, as appropriate for the local climate and receiving water sensitivities:

- 1 **City of Los Angeles Low Impact Development Standards Manual**  
Page E-61/346 of pdf.  
<http://bit.ly/LA-standards>
- 2 **City of San Diego Stormwater Standards**  
Appendix F.3.  
<http://bit.ly/sandiego-standards>
- 3 **Minnesota Stormwater Manual.**  
<http://bit.ly/MN-Standards>
- 4 **Virginia BMP Specification No 9: Bioretention.**  
Section 6.6.  
<http://bit.ly/chesapeake-stormwater>
- 5 **Eastern Washington Stormwater Management Manual**  
Chapter 4.4.2.2.  
<http://bit.ly/WA-standards>
- 6 **Bay Area Stormwater Management Agencies Association (BASMAA)**  
Regional Biotreatment Soil Specification.  
<http://bit.ly/bayarea-standards>

If the flow rate through the system is governed by the media (i.e., the outlet has not been configured to control the flow rate), ensure that the media selected for use will provide a flow rate that is within local requirements for bioretention.

## Tree Selection Guidelines

Trees are an important component of the Silva Cell system. Approximately one tree should be installed for every 250 square feet of Silva Cell modules. Trees are the preferred type of vegetation for all stormwater applications. Components of tree installation are summarized below.

### 1

**Tree selection** — The local street tree palate and city or county guidelines (if any) should be consulted when selecting a tree for a Silva Cell system. Climate and irrigation needs are also important factors to consider; consult with a landscape architect to ensure that these needs can be met in the Silva Cell system location. There are no specific species or size requirements for a successful Silva Cell system.

### 2

**Soil volume** — Trees thrive in Silva Cell systems because they have access to oxygen, water, and larger than average uncompacted soil volumes. For bioretention applications, the tree and tree roots are an essential design component. The roots not only are responsible for 45–70% of total water use, but also prevent soil clogging as the roots grow into the soil mass. Larger trees require

a greater volume of soil for healthy root growth. As the mature tree size (and trunk diameter) increase, the amount of soil volume required to support the tree will increase as well. In general, every 1 cubic foot to 3 cubic feet of soil results in 1 square foot of projected tree canopy diameter. A 16-inch-diameter tree with a 35-foot-high canopy requires about 1,000 cubic feet of soil. Ensure that the tree opening included in the design will provide sufficient room for the needed soil volume needs can be met in the Silva Cell system location. There are no specific species or size requirements for a successful Silva Cell system.

**Trees thrive in  
Silva Cell systems  
because they have  
access to oxygen,  
water, and larger than  
average uncompacted  
soil volumes.**



# 5

## Sizing Guidelines

Silva Cell facilities can be designed to provide stormwater retention, biofiltration, and/or detention.

- 1 Retention refers to water that is held in the system and lost to infiltration or evapotranspiration
- 2 Biofiltration refers to water that is stored and filtered through biofiltration media in the system and ultimately leaves the system via an outlet to the storm drain.
- 3 Detention refers to water that is held and released at a slower rate, with or without treatment.

Retention and/or biofiltration volumes provided via a Silva Cell system design can be used to meet local stormwater quality requirements. Detention can be configured into any design to also provide flow control.

This Fact Sheet does not describe how to determine locally-applicable sizing methods and requirements. However, this Fact Sheet does provide guidance for estimating the retention and biofiltration volume that is provided in a given Silva Cell system design. Additionally, this Fact Sheet provides guidance for modeling the detention effect of the Silva Cell.

## Terms and Concepts Associated with Silva Cell Sizing

The following terms are used in this section as part of determining the amount of volume provided by a Silva Cell system:

### 1

**Discharge elevation** refers to the lowest elevation at which the water discharges to the storm drain from the Silva Cell underdrain. If the underdrain is at the bottom of the facility and there is no upturned elbow on the underdrain, the discharge elevation is at the bottom. If there is an upturned elbow, the overflow elevation is at the crest of the upturned elbow.

### 2

**Overflow or bypass elevation** refers to the highest water elevation in the system before untreated water begins to discharge to the storm drain system or before the system begins to bypass untreated water. The part of the system above the overflow or bypass elevation is not

effective for stormwater management. This elevation may be associated with the pipes which discharge into and from the inlet structure.

### 3

**Total pore storage** or total porosity refers to the total volume of water in soil or gravel pores. This value is typically around 0.45 (as a fraction of total soil volume; corresponds with findings from Rawls, 1983 for Sandy Loam and Loamy Sand).

### 4

**Total available pore storage** refers to the volume of pores that is reasonably available for water storage at the end of an extended dry period. This is generally the difference between total porosity and wilting point. For loamy sands, this is approximately 0.35. For gravel and coarse sands, this is approximately 0.4 (these porosity values correspond with findings from Rawls, 1983, and have been reported in the United States Environmental Protection Agency [USEPA] Stormwater Management Model [SWMM] Manual (USEPA, 2010) and many stormwater technical manuals, including the 2014 Stormwater Management Manual for Western Washington [Washington Department of Ecology, 2014], and others).

### 5

**Freely drained pore storage** refers to the portion of the total pore storage that drains from the soil after a storm event. It is generally the difference between total porosity and field capacity. Freely drained porosity is typically 0.25 (as a fraction of total soil volume) in a loamy sand soil and is approximately 0.40 in a gravel or coarse sand.

## 6

**Suction pore storage** refers to the portion of the total pore storage that is held in the soil via natural suction forces and can only be lost to evapotranspiration. It is generally the difference between the field capacity and the wilting point. Suction porosity is typically 0.10 (as a fraction of total soil volume) in a loamy sand soil and is not significant in a gravel or coarse sand.

## 7

**Silva Cell volume** refer to the portion of the gross volume of the Silva Cell structure that can be occupied by soil, rock, or empty space. Silva Cell volume per module: 1x=13.23 cubic feet/0.3721 cubic meters, 2x=24.76 cubic feet/0.6964 cubic meters, 3x=34.50 cubic feet/.9701 cubic meters.

## 8

**Silva Cell treatment area** is the approximate equivalent treatment area provided by a single Silva Cell module. One Silva Cell module = 10 square feet of treatment area. This should be calculated independently if different media depths or porosities are used than those assumed for typical bioretention per local regulations.

## 9

**Bulk media volume** refers to the total media volume provided in the system below the overflow elevation, accounting for the project-specific Silva Cell geometry and the resulting available Silva Cell volume. This may need to be further subdivided between the bulk media volume below the discharge elevation and above the discharge elevation.

## 10

**Bulk gravel volume** refers to the total gravel volume provided in the system below the overflow elevation, accounting for the Silva Cell geometry and the resulting available Silva Cell volume. There is not typically an adjustment needed for distribution pipes.

## 11

**Pre-filter distribution storage volume** refers to the effective volume above the media layer and below the overflow elevation that serves to distribute water over the media bed and detain water so that it can enter the pores of the system. This is often the same as the bulk gravel volume.

## 12

**Saturated filtration rate** refers to the rate at which water moves through the biofiltration media when the system is saturated. This may vary based on the applicable bioretention soil specification that is used. If an outlet control system is used on the underdrains to control the rate of flow (rather than the permeability of the media), the saturated filtration rate should be assumed to be equivalent to the outlet controlled discharge rate for the purpose of sizing. This value should account for any factor of safety needed.

## 13

**Design infiltration rate** refers to the rate at which water infiltrates into the underlying soil. This value should account for an appropriate factor of safety on measured values.

*These terms are used in the following sections to describe how retention and biofiltration storage should be calculated.*

## Calculating Retention Volume

The retention volume is the volume which is infiltrated or evapotranspired by the facility. Silva Cell systems may be designed to provide retention of the full storage depth or a portion of the storage depth.

The retention volume consists of the full available pore or open storage below the discharge elevation. Additionally, retention volume can include the suction storage of the soil above the discharge elevation and below the overflow elevation.

- 1 For a full infiltration system, the retention volume is equivalent to the total available pore volume associated with the bulk media volume and bulk gravel volume below the overflow elevation, or, if open storage, the Silva Cell structure volume.
- 2 For a bioinfiltration system, this will be the total available pore volume associated with the bulk media volume below the discharge elevation and the suction storage associated with the bulk media volume above the discharge elevation and below the overflow elevation.
- 3 Local guidance may require that credit only be given for the volume that infiltrates or evapotranspires within a given period after the end of a storm. Generally, infiltration should only be used where the infiltration storage can drain within 48 hours after the storm to prevent root rot and ensure there is storage capacity for a subsequent storm.

## Calculating Biofiltration Volume

The biofiltration volume can be calculated using the simple volume method or the simple routing method.

---

### Simple Volume Method

The biofiltration volume provided in the Silva Cell system can be calculated as the total available pore volume associated with the bulk media volume and bulk gravel volume above the discharge elevation, minus any media suction storage volume already credited as retention per the guidance above.

---

### Simple Routing Method

A simple routing method can be used to calculate the additional volume that is filtered during a typical storm event. If allowable, this filtered volume can be added to the static storage volume in the facility (per the simple method above) to calculate the full biofiltration volume.

The volume of water filtered during the event can be calculated as the plan view area of the filtration area of the Silva Cell system multiplied by the depth of water that may be filtered during the design storm event, using the equation on the following page.

The saturated filtration rate should be identified based on the selected bioretention media mixture and should include at least a factor of safety of two on the rate identified in the applicable soil design specification to account for clogging.



$$V_{\text{filtered}} = \frac{A_{\text{filtrationbed}} \times K_{\text{sat}} \times T_{\text{routing}}}{12 \text{ in/ft}}$$

$V_{\text{filtered}}$	volume water that may be filtered during the design storm event (cubic feet)
$A_{\text{filtrationbed}}$	the effective plan view surface area of the portion of the system that contains biofiltration media to filter water (square feet, should account for the Silva Cell treatment area only).
$K_{\text{design}}$	saturated filtration rate (inches per hour).
$T_{\text{routing}}$	duration that may be assumed for routing calculations; this should be assumed to be three hours to represent a conservative storm length (shorter than most storms) unless acceptable rationale for an alternative assumption is provided.

## Guidelines for Ensuring Full Utilization of Soil Pores

Most of the retention and biofiltration volume provided by typical Silva Cell systems is within the pores of soil. This volume is not instantaneously available for incoming water, as the rate of water movement through soil is limited by the soil permeability and hydraulic gradient. As part of effective sizing, it is necessary to ensure that the soil pores will be fully utilized under most conditions prior to the system bypassing.

A simple method for ensuring this is to provide approximately one-third of the total storage volume within the pre-filter distribution storage volume, defined above. This helps provide equalization storage so that storm runoff can enter the pore storage of the system without bypassing prematurely. The pre-filter distribution storage should only include the storage in gravel pores above the media surface and below the overflow or bypass elevation.

*Alternative methods may be proposed with justification.*

## General Guidance for Modeling Silva Cell Systems in Computer Modeling Programs

Some standards may require modeling to route a design hydrograph or a long-term hydrograph through the system. When using modeling to size the Silva Cell system, the following considerations are recommended:

- 1 If the pre-filter distribution volume is provided meeting the guidelines above, it is reasonable to assume that the total pore volumes within the system are immediately accessible to inflowing water. The total pore volume should be calculated using the Silva Cell volume.
- 2 The flowrate through the facility to the treated discharge outlet should be assumed to be constrained by the saturated filtration rate of the media or the orifice control on the outlet, whichever is lower.
- 3 The infiltration rate (accounting for compaction) can be used to model the steady rate at which water exits the facility to infiltration when freely drained water is present.
- 4 The freely drained pore storage of the system should be accounted for in the model, and may discharge to either infiltration or the treated discharge, depending on the configuration.
- 5 Soil suction storage should be modeled as only being able to leave the system at a rate equivalent to transpiration through the tree. Transpiration is not a significant factor in design storm models but may be significant in long term continuous models.
- 6 Upstream pretreatment, catch-basin, and/or vegetated areas, if modeled, should be modeled separately and outlet to the Silva Cell system.
- 7 When modeling for flow control, the orifice flow rate should be adjusted corresponding to the anticipated outlet control of the system.

*Standard and appropriate modeling approaches should be used that are applicable for the modeling program utilized.*

TABLE 2

**Silva Cell Sizing Guidelines — Sample based on Northern California requirements**

Impervious Drainage Area, sq-ft.	4% Sizing Rule sq-ft.	Sq-ft Treatment Area / Silva Cell	Silva Cells required	Trees required* (1/50)
2,500	100	10	10	1
5,000	200	10	20	1
10,000	400	10	40	1
25,000	1000	10	40	1
50,000	2,000	10	200	4
100,000	4,000	10	400	8

\* Tree species selection based on local requirements. Sizing assumes standard 30' canopy street/plaza trees. Adjust ratio to 1/25 units if using small trees.

12,750 sq-ft impervious drainage area

4% sizing rule yields 510 sq-ft treatment area needed for bioretention

510 sq-ft / (10 sq-ft/Silva Cell) = 51 Silva Cells

51 Silva Cells + 1 or 2 trees

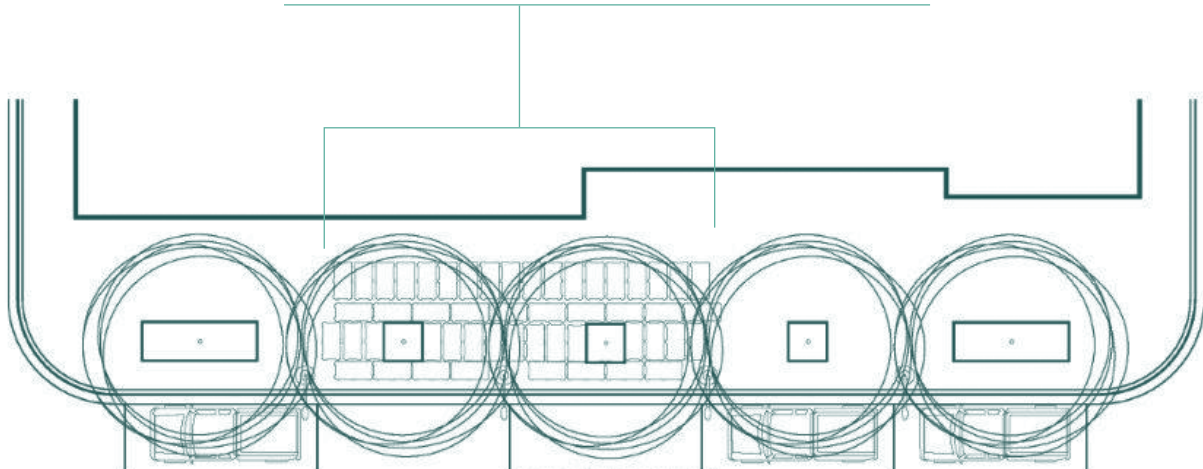



# 6

---

## Operations and Performance

### Construction Considerations

There are several construction-related resources on the DeepRoot website and YouTube channel. A “Silva Cell Two-Deep Installation Instructions” document is provided on the Deep Root website. There are installation videos located on the Deep-Root YouTube channel (DeepRootPartners). It is recommended that these resources be reviewed prior to initiating installation of any facility.

Critical components to consider when planning construction are provided in these resources and include:

## 1

Prepare a detailed schedule of the work for coordination with other trades. Where possible, schedule the installation of Silva Cells after the area is no longer required for use by other trades and work.

## 2

Following excavation of the installation site, the base must be compacted to 95% density as described in the “Facility Geometry” section. Silva Cells cannot be installed on frozen subbase or subgrade soils.

## 3

Following compaction of the subgrade and installation of the subbase, establish the location(s) of the tree opening per the specifications of the Landscape Architect, and mark the inside dimensions on the prepared subbase.

## 4

Place the remaining components of the Silva Cell system in order and as specified in the Installation Instructions document.

Provide construction quality control/quality assurance in accordance with the Installation Instructions document and/or local requirements to ensure that all installation steps are taken in appropriate order. In the event of changed or unforeseen conditions notify the landscape architect or engineer immediately.

## Operations and Maintenance Activities

Common recommended routine inspection and maintenance activities and frequencies are provided in **Table 3**. Additional information and activities can be found in section 3.2 of the Silva Cell Operation and Maintenance Manual ([deeproot.com](http://deeproot.com)).

TABLE 3

**Summary of Routine Inspection and Maintenance Activities**

Component	Recommended Frequency		Inspection Finding/Condition when Maintenance is Triggered	Recommended Maintenance Actions
	Inspection	Routine Maintenance		
<b>Tree Opening</b>	Spring, Fall, and after major storms	<i>As needed</i>	Evidence of clogging, standing water, accumulation of sediment, debris, or trash.	Identify and remove blockages and clean area as needed.
<b>Inlet/outlet structures</b>	Annually	<i>After major storms</i>	Water is not being directed properly in to or out of the Silva Cell facility.	Remove any blockages and clean pipe as needed.
<b>Distribution/underdrain pipes</b>	Annually	<i>Annually</i>	Water is not being distributed within the facility and/or draining through the underdrain pipes per design.	Remove blockages from pipes (e.g., jet clean, rotary cut roots/debris).
<b>Tree</b>	Biannually	<i>As needed</i>	Tree requires pruning for safety reasons, to promote healthy growth, or to prevent the tree from growing in an undesirable manner.	Prune tree as needed for safety to promote healthy growth and to avoid conflicts with adjacent features (i.e., power lines, clearances from buildings or sidewalk, or similar).
	Spring, Fall, and after major storms	<i>As needed</i>	Tree is dying, dead, diseased, or has become a safety hazard.	Install new tree, media, and/or Silva Cell components as needed to restore the facility to its designed configuration.
	Annually	<i>As needed</i>	There is soil or mulch on the root collar.	Clean soil or mulch off root collar until the first set of roots is found; take care not to harm roots.
	Every four to five years	<i>As needed</i>	Girdling roots are found.	Remove girdling roots.
<b>Watering</b>	Monthly	<i>As needed</i>	Tree/vegetation shows signs of being deprived of water or watering is anticipated during prolonged dry periods.	Water appropriately for species, climate, and site conditions to maintain the health of the tree or vegetation. Ensure water is reaching the entire soil column and perimeter, not just the tree opening.
<b>Pest Control</b>	Biannually or as needed	<i>As needed</i>	Tree/vegetation shows signs of wilting, chewing of bark, spotting, or other indicators typical of the region. Damage or erosion caused by animals is present.	Remove/reduce the item or source that is attracting the nuisance animals or insects. Remove diseased or dead plants. Avoid using pesticides and rodenticides.

## Performance Data

Studies have been conducted for the Silva Cell system to examine the water quality performance of the system.

Summaries of those studies are provided below. In general, as the system is configured similarly and is expected to function equivalent to bioretention hydraulically, the water quality performance is expected to be similar to bioretention when bioretention media is installed.

A Silva Cell study performed by North Carolina State University (NCSU) demonstrated the water quality results summarized in **Table 4** below (NCSU, 2017; pg et al., 2015).

A Silva Cell study performed by Toronto Water demonstrated water quality improvements from a single monitored storm event (on 2 November 2016), summarized in **Table 5** (Cheung et al., 2017).

A study performed by the Credit Valley Association of Canada found hydrologic and hydraulic benefits using Silva Cells which are consistent with other green infrastructure installations. A summary of these benefits is provided below (DeepRoot and Credit Valley Conservation, 2016):

- 1 Average runoff reduction for all eight hydrologic events observed was 97%.
- 2 Storm events with depths less than 25 millimeters made up 63% of the total events.
- 3 These events had a 98% volume reduction.
- 4 Peak flow was reduced by 96% on average.
- 5 The average lag time for events that produced outflow was 35 minutes.

A study conducted in Manchester, United Kingdom also demonstrated hydrologic and hydraulic benefits. Provisional results from that study are provided below:

- 1 70% average storm peak reduction.
- 2 60% average water volume retention by the Silva Cell system.
- 3 Up to 2 hours (average 90 minute) delay (i.e., attenuation) in stormwater entering the system.

TABLE 4  
NCSU Silva Cell Water Quality Performance Findings

Pollutant	Percent Removal	Median Effluent Concentration <i>milligrams per liter (mg/L) or micrograms per liter (µg/L)</i>
Total Nitrogen	65–80%	0.25–0.40 mg/L
Nitrate-Nitrite (as Nitrogen)	35–60%	0.05–0.10 mg/L
Total Ammonia Nitrogen	70–75%	0.05–0.10 mg/L
Total Phosphorus	70–75%	0.05–0.10 mg/L
Orthophosphate	70–80%	0.01–0.05 mg/L
Total Suspended Solids	85–90%	5–10 mg/L
Copper	85–90%	1–3 µg/L
Lead	90–95%	1–3 µg/L
Zinc	75–85%	10–15 µg/L



TABLE 5

**Toronto Water Silva Cell Water Quality Performance Findings**

Parameter	Influent (mg/L)	Effluent (mg/L)	Percent Reduction
Aluminum	0.853	0.138	83.8%
Arsenic	0.000654	0.000287	56.1%
BOD	63.00	18	71.4%
Chloride	25.9	21.5	17.0%
Chromium	0.0079	0.00166	79.0%
Copper	0.0302	0.0144	52.3%
Iron	2.43	0.287	88.2%
Lead	0.00584	0.00064	89.0%
Manganese	0.175	0.013	92.6%
Nickel	0.00383	0.00316	17.5%
Potassium	8.59	4.47	48.0%
Total Phosphorus	0.607	0.082	86.5%
Total Suspended Solids	58	2	96.6%
Zinc	0.106	0.025	76.4%

## References

1. Cheung, P. and R. Anderton, 2017. *The Queensway Sustainable Sidewalk Pilot Project*. Proceedings of the 6th Annual TRIECA Conference. 22 March 2017
2. DeepRoot and Credit Valley Conservation, 2016. *Central Parkway, Low Impact Development Infrastructure Performance and Risk Assessment*. May 2016
3. NCSU, 2017. *Soils Beneath Suspended Pavements: An Opportunity for Stormwater Control and Treatment*. Presented by Jonathan L. Page, P.E. 9 March 2017.
4. Page, J.L., R.J. Winston, and W.F. Hunt, III, 2015. *Soils Beneath Suspended Pavements: An Opportunity for Stormwater Control and Treatment*. *Ecological Engineering*, 2015, 82: 40 – 48.
5. Rawls, W.J, D.L. Brakensiek, and N. Miller, 1983. *Green-Ampt Infiltration Parameters from Soils Data*. *Journal of Hydraulic Engineering*, 1983, 109 (1): 62 – 70.
6. USEPA, 2010. *Stormwater Management Model User's Manual, Version 5.0*. Lewis A. Rossman. July 2010.
7. Washington Department of Ecology, 2014. *2014 Stormwater Management Manual for Western Washington*. Volume III – Hydrologic Analysis and Flow Control BMPs, Appendix III-C: Washington State Department of Ecology Low Impact Development Flow Modeling Guidance.

## Patents

*The Silva Cell is covered by one or more of the following patents:*

**United States:** 7,080,480 | 8,065,831 | 9,085,886 | 9,085,887 | 9,775,303

**Canada:** 2,552,348 | 2,662,129 | 2,829,599

**United Kingdom/Europe:** EP 2059114



